



Beta Three

USER MANUAL **EN**

XC2.6

DIGITAL SPEAKER CONTROLLER



UM- XC2. 6- 20090425 v e r A

TABLE OF CONTENTS

1. CAUTION	1
2. INTRODUCTION	2
2.1 Major feature	2
2.2 Audio feature	2
2.3 User interface	2
2.4 Other feature	2
3. UNPACKING	3
4. AC POWER SUPPLY REQUIREMENT	3
5. FRONT PANEL CONTROL FEATURE	4
6. BACK PANEL CONNECTION FEATURE	4
7. DISPLAY AND OPERATION	5
8. CONFIGURATION PROGRAM UPGRADE	5
9. TROUBLESHOOTING	6
10. TECHNICAL SPECIFICATION	7
11. BLOCK DIAGRAM	7
12. INSTALLATION DIMENSION	8

1. CAUTION

Instruction:



The lightning flash with arrowhead symbol within the equilateral triangle is intended to alert the user to the presence of un-insulated “dangerous voltage” within the product's enclosure that may be of sufficient magnitude to constitute a risk of electric shock.

The exclamation point within the equilateral triangle is intended to alert the user to the presence of important operation and maintenance (servicing) instructions in the literature accompanying this appliance.

Do not open the cover:



Do not open the cover to avoid the risk of electric shock caused by high voltage parts in the product. Any problems caused by user's wrong actions are out of warranty.

Do not damage the cord:



the cord Please hold the plug when pulling out or plug in the cord. Do not pull out or touch the cord with wet hand, or it will cause the risk of electric shock. Power supply cords should be routed so that they are not likely to be walked upon or pinched by items placed on or against them. When removing the cord from a power outlet be sure to remove it by holding the plug attachment and not by pulling on the cord.

Avoid object and liquid entry:

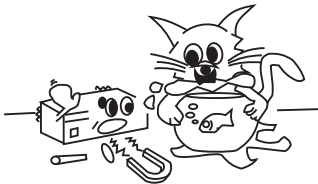

Take care that objects do not fall into and that liquids are not spilled into the inside of the product. If the object or liquid enter the product, please ask qualified personnel to check it.

Abnormal status:



In the event of abnormal noise and smell, please put off the power supply and pull out the cord, please ask qualified personnel to check it.

Nonuse for a long time:

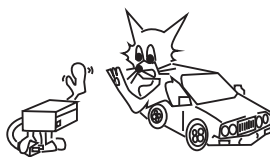

When nonuse it for a long time, please put off the power supply and pull out the cord to avoid the unexpected dangers.

2. INTRODUCTION

Thank you very much for purchasing of XC2.6 digital speaker controller whose brand is β 3 from Elder audio company. The product have cohered elder company's more than ten years cherish experience in the field of professional audio system,. The excellent voice performance and the competitive price will guarantee your profit from your investment.

X2.6 provide digital process to the two way analogue input and six way output audio signal and the function of frequency process and speaker management. It is very suitable for the improvement of the sound reinforcement in the middle small place.

X2.6 based on the previous EC Series speaker controller, after special improvement with simple character and attractive price to meet the market.

It is different from the former speaker controller, to convenient for the user, it is with many speaker programmers. The user only need to select our company's sound reinforcement system and adopt the related programmers in the speaker, then he can set up a perfect system quickly.

2.1 Main features:

1. Multi functions process: one controller can meet cross over, EQ and dynamic process.
2. The signal route are all digital process,48 digital DSP and 24 digital line AD/DA transfer technology to ensure the sound is dynamic and clear.
3. Classical calculation and double precise filter to meet PA dynamic and precise requirement.
4. The filter and signal dynamic process point in the signal route can make It is better to fit the speaker.
5. Professional XLR in-out socket is very durable.
6. Perfect hardware anti disturb(RF/ESD protection) with strong software correction technology to make the system run well.
7. Well-suited programmer update software, it can update all kinds of speaker programmer to the certain state by USP connecting to the computer.
8. Panle signal dynamic indication.
9. Panel key+coder to sort and transfer programmer quickly.
10. LCD display programmer information for sorting.

2.2 Audio features:

XC2.6 get samples at 48KHZ,the distinguish rate is the famous 24's-EA/D and D/A switch technology, signal handing take the high capability 32 DSP and filter, the digital processor including the gain controller, polarity, PEQ (peak, slope, limit and band pass),delay, crossover. (the types are butter worth/Bessel/linkwitz, the slope rate are 12db-36db)limiter. All of input and output connector take the precise electronic equalization and RF protect circuit and the standard XLR socket is reliable.

2.3 User interface

The panel include the signal peak indicator with LED input, user process information with LCD display.

2.4 other character

There are 50 groups programmer for the user, one USB communication signal connection. The user can upgrade to the inner programmer by the suit PC software.

3. UNPACKING

Each product have to be packed carefully before ex warehouse as part of our quality system control. Please check carefully on the product's appearance. For the future's convenience of transport and guarantee the product safety and capability, please keep all of the packing material well. Please inform the distributor immediately in the convenience of provide the letter guarantee if finding the appearance damage on the product.

4. AC POWER REQUIREMENT

Please confirm the local voltage is the same as input marker on the AC socket or being included within the range before connect this machine to the local power. The machine have fuse inside and general speaking , the fuse is damaged if the machine fail to connect to the power. In this situation, please contact with our professional repair person to change another new one same as the fuse type.

5. FRONT PANEL CONTROL FEATURE

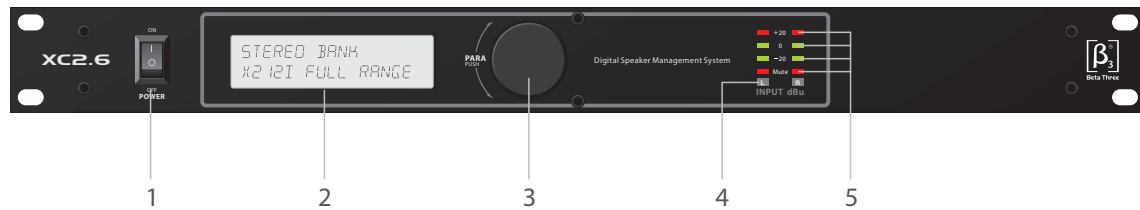

1. Power switch: Put the 1 means "TRUN ON" and 0 means "TRUN OFF".
2. LCD display: Display the program which is using.
3. The coder with "PUSH" function, browse and transfer the configuration program.
4. MUTE indicator LED, LED on means mute output, LED off means normal output.
5. INPUT signal LED: Peak, total 3 levels: -20dBu (green), 0dBu (yellow), +20dBu (red)

6. BACK PANEL CONTROL FEATURE

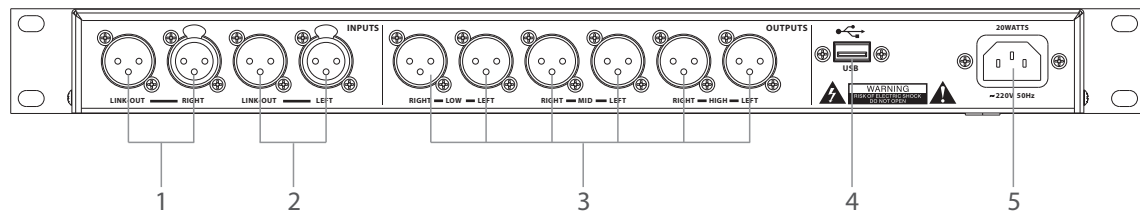

1. R channel audio input socket and link-out socket
2. L channel audio input socket and link-out socket
3. High, mid, low frequency channel output of L/R, total 6 channels, usually configure as 3-way stereo.
4. USB port for configuration program upgrade.
5. Power supply socket for connecting with local AC power.

7. DISPLAY AND OPERATION

Power on the device and it will display the present program number and name as below:



Preset 01
Stereo FullRange

Built-in configuration program browse and transfer

Rotate the coder on panel, enter program browse status:



Recall: Preset 02
Name: Mono FullRange

Under this interface, press "PUSH KEY" to enter program transfer interface:



Recall: Preset 02
Recall: N/Y?

Rotate the coder to choose "N" and "Y".

After Choosing "N", it won't execute "transfer" and back to main menu (display the present program).

After Choosing "Y" and execute number 2 program, the interface is as below:

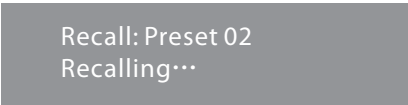

Recall: Preset 02
Recalling...

After program transfer, then display the main interface, the current program number become 2.



Preset 02
Mono FullRange

8. THE CONFIGURATION PROGRAM UPGRADE

Via USB port, to connect the device with computer, run the relevant update.exe software to upgrade the configuration program, see below photo:

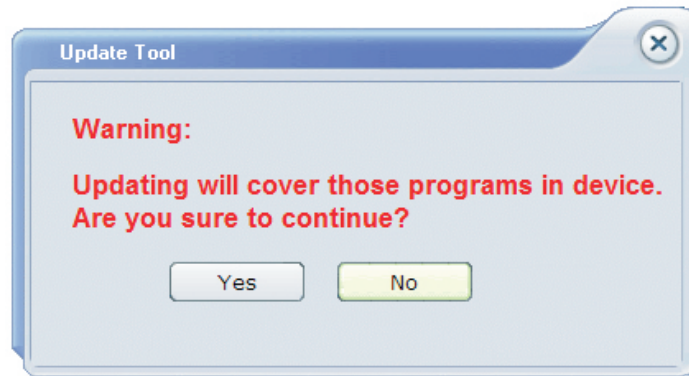

Click "Yes" to start the program update, click "No" to exit the update.

9. TROUBLESHOOTING

Problem	Check and Solution
Can't power on	whether power cord is well connected? Power switch is turned on or not?
Overload light is often on	Lower the input signal, the biggest input of this device is +20dBu.
System hum noise	Check up the system connection, pay attention to the pre and post equipment's ground connection.
Unsuccessful program upgrade	Check up the USB drive is correctly installed or not? USB wire is well connected? Re-plug in the USB wire.

10. SPECIFICATIONS

Analog Input:

Input: balance XLR-3-32 input socket
Input Impedance: unbalance $\geq 10k\Omega$, balance $\geq 20k\Omega$
Max input level: $\geq +20dBu$ (THD+N = 0.1%)
A/D Convertor: 48kHz sample frequency, 24bits linear

Analog Output:

Input: balance XLR-3-32 out put socket
Output Impedance: unbalance $\leq 50\Omega$, balance $\leq 100\Omega$
Load impedance: $\geq 600\Omega$
Max input level: $\geq +20dBu$ (THD+N = 0.1%)

Simulation Sound:

Frequency response: 20Hz~20 kHz (+0.3/-0.3dB), 10Hz~30kHz (+0.3/-3.0dB)
Dynamic range: $\geq 110dB(A -Weight)$
Total distortion and noise : THD+N $\leq 0.008\%$ (+4dBu@1kHz Excluding the right to)
Intermodulation Distortion : $\leq 0.02\%$ (+4dBu@60Hz/7kHz)
Min time of delaying: about 1.2ms (we set the delaying parameter of signal input and output as 0)

Others:

Power requirement: AC 220V 50Hz
Power consuming: $\leq 18W$
The fuse: 250mA@220V AC delaying
Dimension(W \times D \times H): 482 \times 172 \times 45mm
Weight: 3.0kg
Operation temperature: 0~+40°C
Storage temperature: -10~+60°C

Accessories:

Power cable: 1 pcs
USB cable: 1 pcs
User manual: 1 pcs
CD: 1 pcs

Exterior design and specifications are subject to change without notice

11. BLOCK DIAGRAM

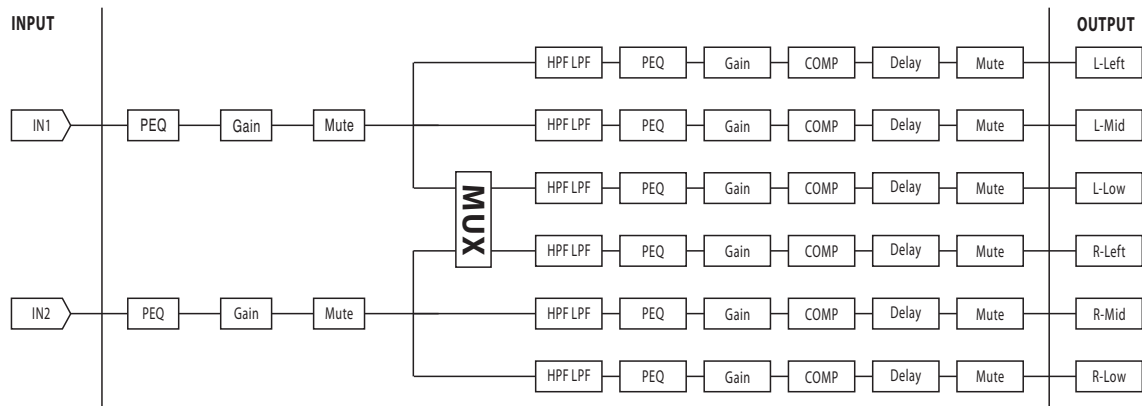

12. INSTALLATION DIMENSION

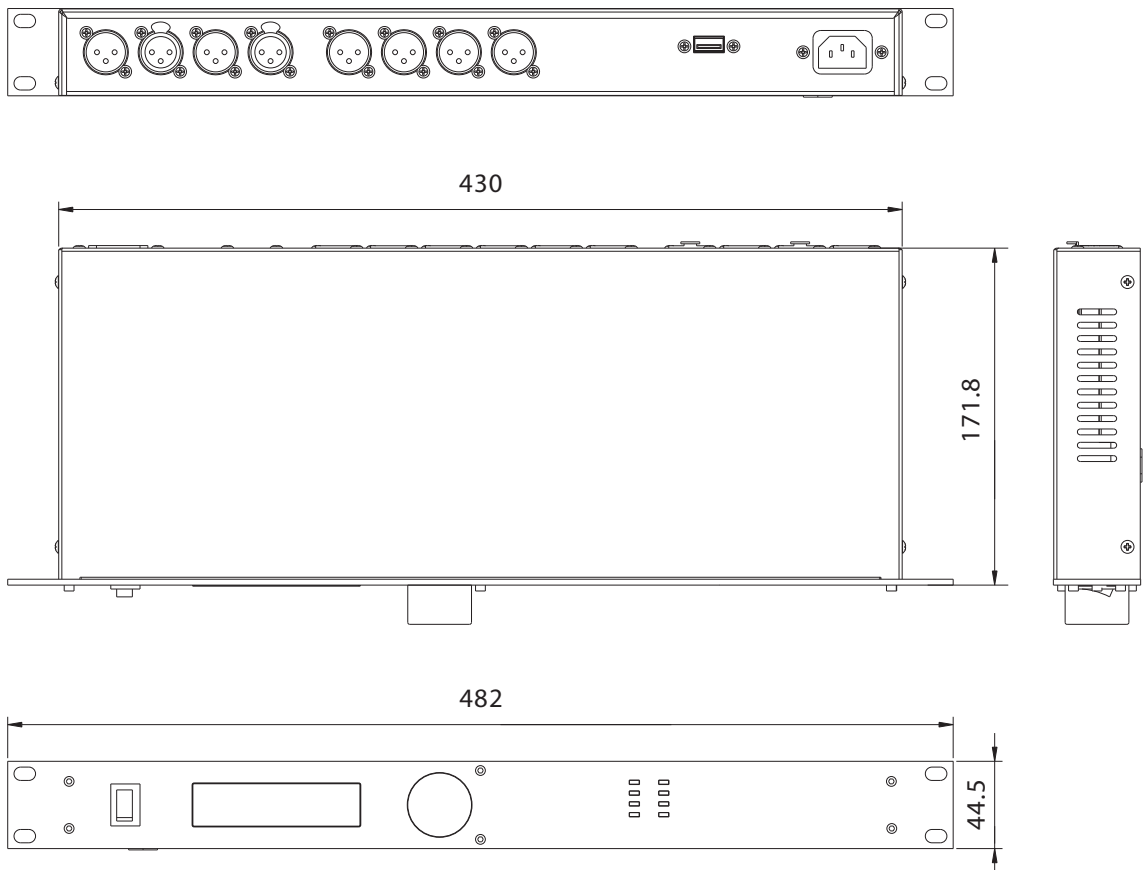

Notes:



Beta Three