

Features:

- Two-way passive speaker with one 8" woofer and one 1.5" driver.
- Cabinet is made from polypropylene and special high-tech material in large injection mold. It's durable, anti-shock and has good damping characters.
- Voice coil in the 8" woofer is made from $\varnothing 50\text{mm}$ copper cladding aluminium ribbon wire.
- Heavy duty protective grille.
- The high frequency driver is protected by special design circuit to avoid being damaged when overload.
- Rotatable $90^\circ \times 60^\circ$ (HxV) dispersion horn makes it suitable for any performance purposes.
- Arrayable vertically in 4 layers or horizontally in more than 8 columns.

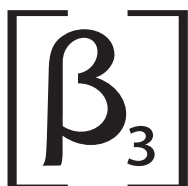

Beta Three

Model:N8

Technical Parameters

System:	Built-in Crossover Two Way Full Range Speaker
Driver Quantity:	8" x1(Bass) 1x $\varnothing 34\text{mm}$ Driver
Frequency Response(-3dB):	75Hz-18KHz
Frequency Response(-10dB):	60Hz-20KHz
Sensitivity(dB/1M/1W):	92 dB
Impedance:	8 Ohm
Recommendatory Power(RMS/W):	100 W
Tweeter Dispersion(HxV):	$90^\circ \times 60^\circ$
Harmonic Distortion:	$\leq 1\%$
Connectors:	1xNL4
Dimensions(WxDxH mm/pcs):	277X257X400mm
Packing Dimensions(WxDxH mm/pair)	595X310X460mm
Net Weight(Kg/pcs):	6.5Kg
Gross Weight(Kg/pair):	15.0Kg

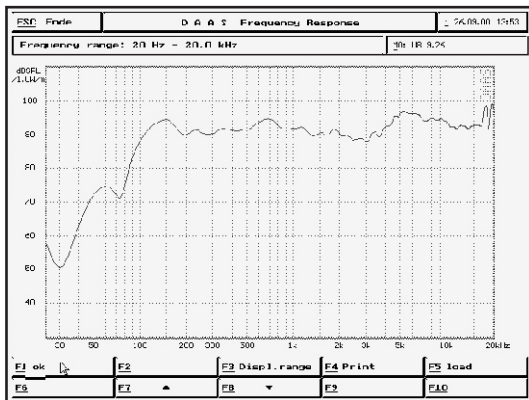

Frequency response, SPL/2.83v

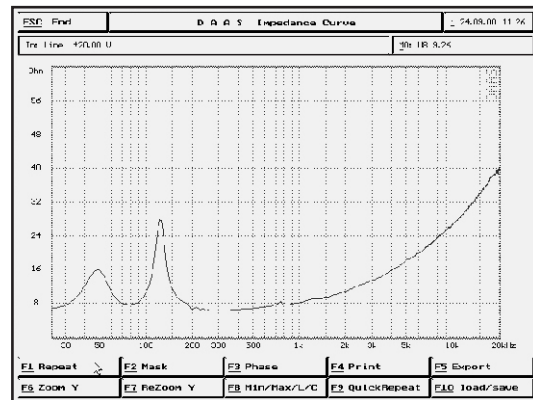

Impedance curve

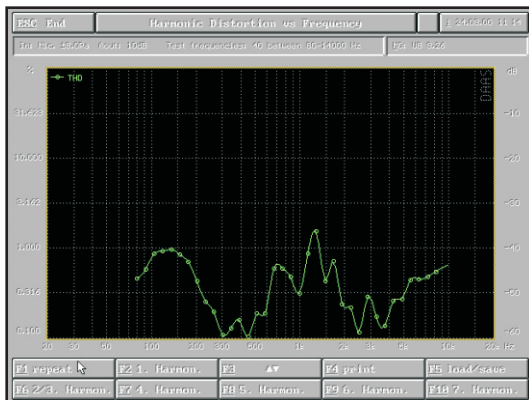

Harmonic distortion 106dB/2.5m, nominal impedance

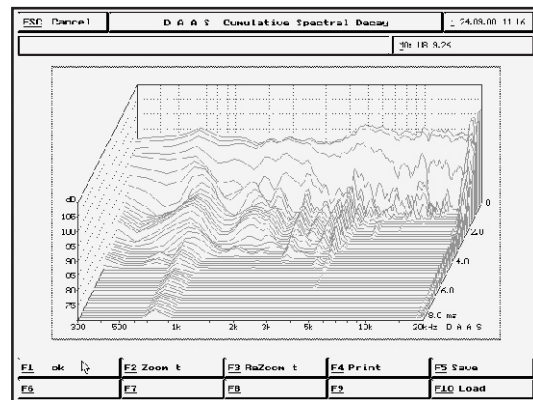

Waterfall spectrum analysis

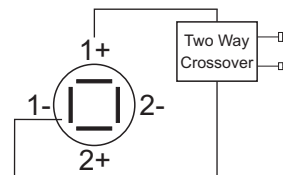
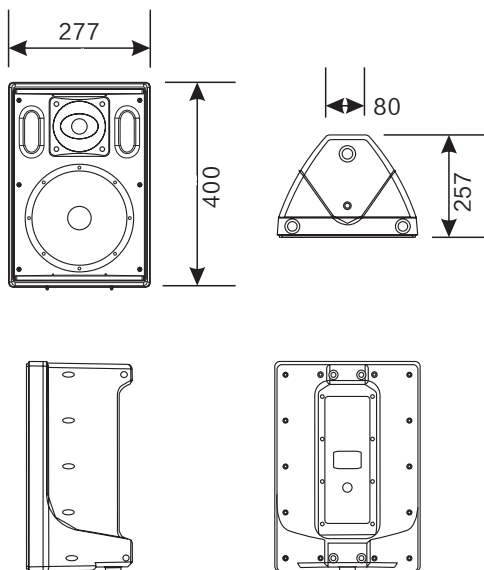

Two Way Crossover

Cosmetic changes may be made